

Universal lighting track system

Track lighting provides a way of installing spotlights into a space that is flexible to future changes, allowing spotlights to be added, removed or repositioned quickly without the need for any cabling. Attachments include the Pitch-M, Pitch-L and Pivitz.

- Recessed or surface mount versions
- 3-Circuit or DALI 3-circuit versions
- Modular connections for extending/joining track
- Track can be cut to size during installation if required. Bending tool is required
- Surface track can be suspended using optional wire suspension kit - see finishing components
- Maximum system current 16A
- Black and silver finishes available to special order (minimum order quantity applies)

Notes: See installation guide for mounting point locations

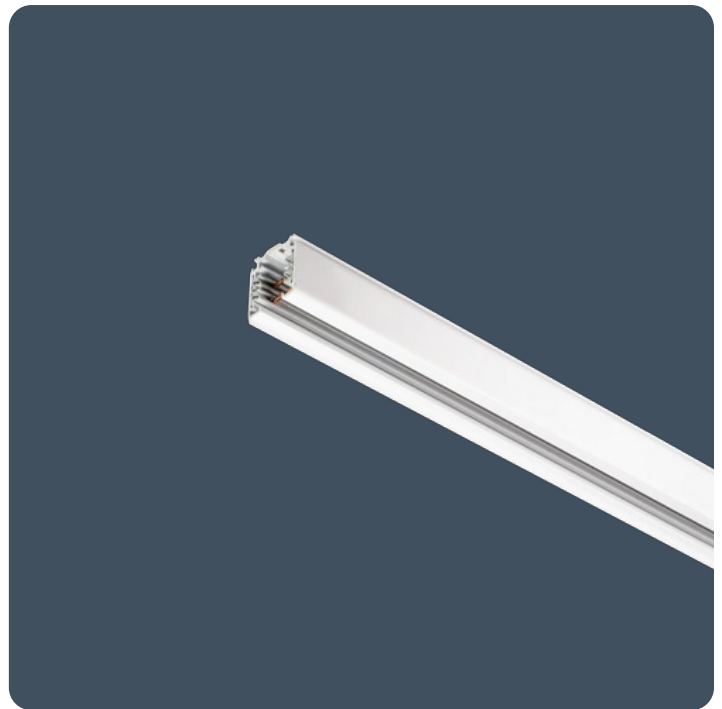

IP20

Specification

Mounting	Track	IP rating	IP20
Nominal size	1 m 2 m 3 m		

Compliance

UKCA	Yes	CE	Yes
------	-----	----	-----

Dimensions

3-Circuit Track

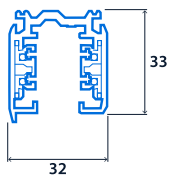

3-Circuit Track Recessed

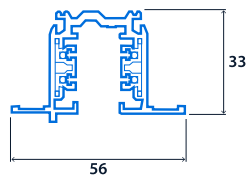

DALI 3-Circuit

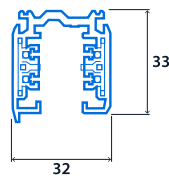

DALI 3-Circuit Recessed

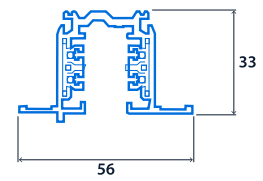

Cover Plate - Cross (Recessed Feed)

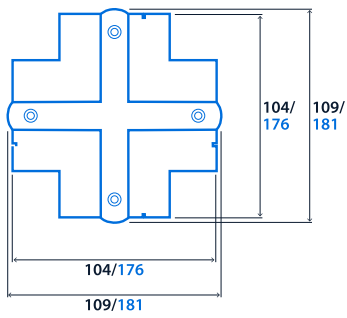

Cover Plate - Straight (Recessed Feed)

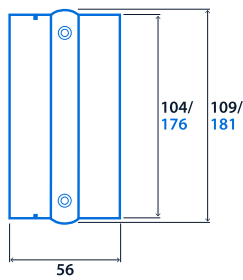

Flexible Coupler

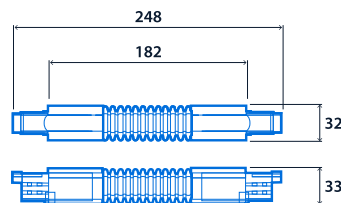

Straight Coupler

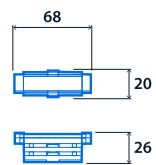

Tee Feed/Coupler

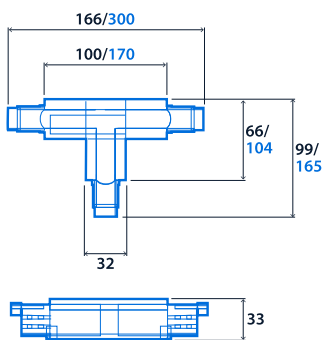

Angled Feed/Coupler

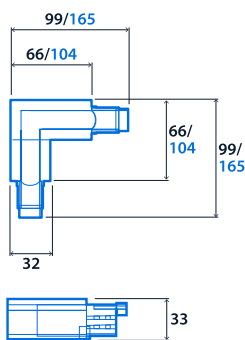

Cross feed

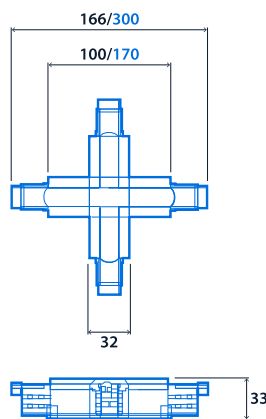

Feed

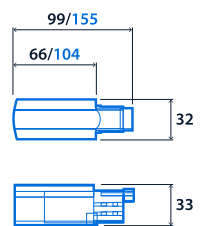

NOTE: Dimensions 3-Circuit/DALI 3-Circuit

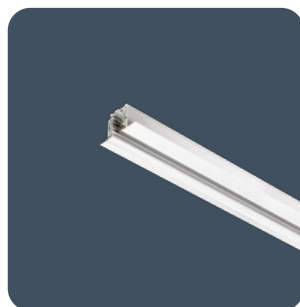
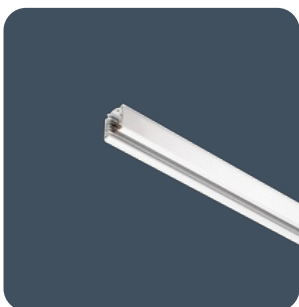



Click or scan here
View Track variants using our
online filtering tool



Information is correct as of 29 Dec 2024, however must not be interpreted as a guarantee of individual product performance and/or characteristics. We reserve the right to alter specifications and designs without prior notice.